

# SD400 | 12.5L | 400 kW

## INDUSTRIAL DIESEL GENERATOR SET

EPA Certified Stationary Emergency

### Standby Power Rating

400 kW, 500 kVA, 60 Hz

### Prime Power Rating\*

360 kW, 450 kVA, 60 Hz



\*Assembled in the USA using domestic and foreign parts

\*EPA Certified Prime ratings are not available in the US or its Territories

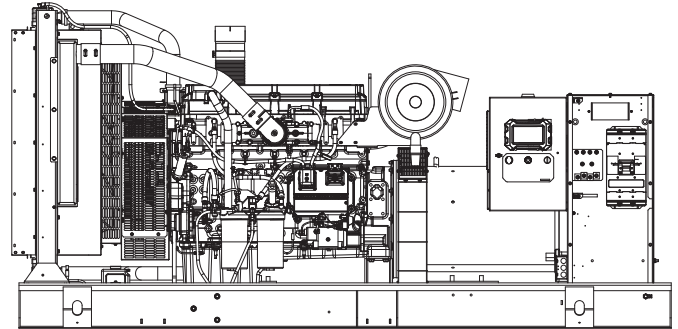

## Codes and Standards

**Not all codes and standards apply to all configurations. Contact factory for details.**



UL2200, UL6200, UL1236, UL489,  
UL142



CSA C22.2, B149



BS5514 and DIN 6271



SAE J1349



NFPA 37, 70, 99, 110



NEC700, 701, 702, 708



NEMA ICS10, MG1, 250, ICS6,  
AB1



ANSI C62.41

## Powering Ahead

For over 60 years, Generac has provided innovative design and superior manufacturing.

Generac ensures superior quality by designing and manufacturing most of its generator components, including alternators, enclosures and base tanks, control systems and communications software.

Generac gensets utilize a wide variety of options, configurations and arrangements, allowing us to meet the standby power needs of practically every application.

Generac searched globally to ensure the most reliable engines power our generators. We choose only engines that have already been proven in heavy-duty industrial applications under adverse conditions.

Generac is committed to ensuring our customers' service support continues after their generator purchase.

## STANDARD FEATURES

### ENGINE SYSTEM

- Oil Drain Extension
- Heavy Duty Air Cleaner
- Level 1 Fan and Belt Guard (Open Set Only)
- Stainless Steel Flexible Exhaust Connection
- Factory Filled Oil and Coolant
- Radiator Duct Adapter (Open Set Only)
- Critical Silencer

### FUEL SYSTEM

- Flexible Fuel Lines
- Primary and Secondary Fuel Shutoff

### COOLING SYSTEM

- Closed Coolant Recovery System
- UV/Ozone Resistant Hoses
- Factory-Installed Radiator
- 50/50 Ethylene Glycol Antifreeze
- 120 VAC Coolant Heater

### ELECTRICAL SYSTEM

- Battery Charging Alternator
- Battery Cables
- Battery Tray
- Rubber-Booted Engine Electrical Connections
- Solenoid Activated Starter Motor

### ALTERNATOR SYSTEM

- UL2200 GENprotect™
- Class H Insulation Material
- 2/3 Pitch
- Skewed Stator
- Permanent Magnet Excitation
- Sealed Bearing
- Amortisseur Winding
- Full Load Capacity Alternator

### GENERATOR SET

- Internal Genset Vibration Isolation
- Separation of Circuits - High/Low Voltage
- Separation of Circuits - Multiple Breakers
- Wrapped Exhaust Piping (Enclosed Units Only)
- Standard Factory Testing
- 2 Year Limited Warranty (Standby Rated Units)
- 1 Year Limited Warranty (Prime Rated Units)
- Silencer Mounted in the Discharge Hood (Enclosed Units Only)

### ENCLOSURE (If Selected)

- Rust-Proof Fasteners with Nylon Washers to Protect Finish
- High Performance Sound-Absorbing Material (Sound Attenuated Enclosures)
- Gasketed Doors
- Upward Facing Discharge Hoods (Radiator and Exhaust)
- Stainless Steel Lift Off Door Hinges
- Stainless Steel Lockable Handles
- Modular Construction
- RhinoCoat™ - Textured Polyester Powder Coat Paint

### FUEL TANKS (If Selected)

- UL 142/ULC S601
- Double Wall
- Vents
- Sloped Top
- Sloped Bottom
- Factory Pressure Tested (2 psi)
- Rupture Basin Alarm
- Fuel Level
- Check Valve In Supply and Return Lines
- RhinoCoat™ - Textured Polyester Powder Coat Paint

## CONTROL SYSTEM



### Power Zone® Pro Sync Controller

- NFPA 110 Level 1 Compliant
- Engine Protective Functions
- Alternator Protective Functions
- Digital Engine Governor Control
- Digital Voltage Regulator
- Multiple Programmable Inputs and Outputs
- Remote Display Capability
- Remote Communication via Modbus® RTU, Modbus TCP/IP, and Ethernet 10/100
- Alarm and Event Logging with Real Time Stamping
- Expandable Analog and Digital Inputs and Outputs

- Remote Wireless Software Update Capable
- BMS and Remote Telemetry
- Built-In Programmable Logic Eliminates the Need for External Controllers Under Most Conditions
- Ethernet Based Communications Between Generators
- Programmable I/O Channel Properties
- Built-In Diagnostics
- Arc Flash Maintenance Mode (When Properly Equipped)

### Alarms and Warnings

- Low Oil Pressure
- Low Coolant Level
- High/Low Coolant Temperature
- Sensor Failure
- Oil Temperature
- Over/Under Speed
- Over/Under Voltage
- Over/Under Frequency
- Over/Under Current
- Over Load
- High/Low Battery Voltage
- Battery Charger Current
- Phase to Phase and Phase to Neutral Short Circuits (I<sup>2</sup>T Algorithm)

### 7 Inch Color Touch Screen Display

- Resistive Color Touch Screen
- Sunlight Readable (1400 NITS)
- Easily Identifiable Icons
- Multi-Lingual
- On Screen Editable Parameters
- Key Function Monitoring
- Three Phase Voltage, Amperage, kW, kVA, and kVAr
- Selectable Line to Line or Line to Neutral Measurements
- Frequency
- Engine Speed
- Engine Coolant Temperature
- Engine Oil Pressure
- Engine Oil Temperature
- Battery Voltage
- Hourmeter
- Warning and Alarm Indication
- Diagnostics
- Maintenance Events/Information

## CONFIGURABLE OPTIONS

### ENGINE SYSTEM

- Engine Coolant Heater
- Oil Heater
- Level 1 Fan and Belt Guards (Enclosed Units Only)
- Radiator Stone Guard (Open Set Only)
- Critical Silencer Flange - Shipped Loose (Open Set Only)

### ELECTRICAL SYSTEM

- 20A UL Listed Battery Charger
- Battery Warmer

### ALTERNATOR SYSTEM

- Alternator Upsizing
- Anti-Condensation Heater
- Tropical Coating

### CIRCUIT BREAKER OPTIONS

- Main Line Circuit Breaker
- 2<sup>nd</sup> Main Line Circuit Breaker
- Shunt Trip and Auxiliary Contact
- Electronic Trip Breakers

### GENERATOR SET

- Extended Factory Testing
- 12 Position Load Center

### CONTROL SYSTEM

- NFPA 110 Level 1 Compliant 21-Light Remote Annunciator
- Remote Output Relays (8 or 16)
- Oil Temperature Indication and Alarm
- Remote E-Stop (Break Glass-Type, Surface Mount)
- Remote E-Stop (Red Mushroom-Type, Surface Mount)
- Remote E-Stop (Red Mushroom-Type, Flush Mount)
- 10A Engine Run Relay
- Ground Fault Annunciator
- 100 dB Alarm Horn
- Damper Alarm Contacts (Motorized Dampers Only)
- 120V GFCI and 240V Outlets

### ENCLOSURE

- Level 0 Sound Attenuated
- Level 1 Sound Attenuated
- Level 2 Sound Attenuated
- Level 2 Sound Attenuated with Motorized Dampers
- Steel Enclosure
- Aluminum Enclosure
- Up to 200 mph Wind Load Rating (Contact Factory for Availability)
- Enclosure Heaters (Motorized Dampers Only)
- AC Enclosure Lighting Kit
- IBC Certification

### WARRANTY (Standby Gensets Only)

- 2 Year Extended Limited Warranty
- 5 Year Limited Warranty
- 5 Year Extended Limited Warranty
- 7 Year Limited Extended Warranty
- 10 Year Limited Extended Warranty

## ENGINEERED OPTIONS

### ENGINE SYSTEM

- Fluid Containment Pan

### CIRCUIT BREAKERS

- 3<sup>rd</sup> Breaker Systems

### CONTROL SYSTEM

- Additional Spare Inputs/Outputs (x4)
- Battery Disconnect Switch

### GENERATOR SET

- Special Testing
- Battery Box

### ENCLOSURE

- Door Open Alarm Horn

### FUEL TANKS

- Overfill Protection Valve
- UL 2085 Tank
- Stainless Steel Tank
- Special Fuel Tanks
- Vent Extensions
- 5 Gallon Spill Containment Box
- Dealer Supplied AHJ Requirements

EPA Certified Stationary Emergency

**APPLICATION AND ENGINEERING DATA**

**ENGINE SPECIFICATIONS**

**General**

Make	Perkins
Model	2206D-E13TAG3
Tier Level	3
EPA Emissions Compliance	Stationary Emergency
EPA Emissions Reference	See Emissions Data Sheet
Cylinder #	6
Type	In-Line
Displacement - In <sup>3</sup> (L)	762.80 (12.5)
Bore - in (mm)	5.12 (130)
Stroke - in (mm)	6.18 (157)
Compression Ratio	16.3:1
Intake Air Method	Turbocharged/Aftercooled
Cylinder Head	4-Valve
Piston Head	Aluminum
Crankshaft Type	Dropped Forged Steel

**Engine Governing**

Governor	Electronic Isochronous
Frequency Regulation (Steady State)	±0.25%

**Lubrication System**

Oil Pump Type	Gear
Oil Filter Type	Full Flow
Crankcase Capacity - qt (L)	40.15 (38)

**Cooling System**

Cooling System Type	Closed Recovery
Fan Type	Pusher
Fan Speed (rpm)	1,656
Fan Diameter - in (mm)	36.5 (927)

**Fuel System**

Fuel Type	Ultra Low Sulfur Diesel Fuel #2
Fuel Specifications	ASTM
Fuel Filtering (Microns)	Primary 10- Secondary 2
Fuel Inject Pump Make	Electronic
Fuel Pump Type	Engine Driven Gear
Injector Type	MEUI
Engine Type	Pre-Combustion
Fuel Supply Line - in (mm)	0.5 (12.7) NPT
Fuel Return Line - in (mm)	0.5 (12.7) NPT

**Engine Electrical System**

System Voltage	24 VDC
Battery Charger Alternator	Standard
Battery Size	See Battery Index 0161970SBY
Battery Voltage	(2)-12 VDC
Ground Polarity	Negative

**ALTERNATOR SPECIFICATIONS**

Standard Model	K0400124Y21
Poles	4
Field Type	Revolving
Insulation Class - Rotor	H
Insulation Class - Stator	H
Total Harmonic Distortion	<5%
Telephone Interference Factor (TIF)	<50

Standard Excitation	Permanent Magnet
Bearings	Single Sealed Cartridge
Coupling	Direct via Flexible Disc
Prototype Short Circuit Test	Yes
Voltage Regulator Type	Full Digital
Number of Sensed Phases	All
Regulation Accuracy (Steady State)	±0.25%

**OPERATING DATA**

**POWER RATINGS**

		Standby
Three-Phase 120/208 VAC @0.8pf	400 kW	Amps: 1,388
Three-Phase 120/240 VAC @0.8pf	400 kW	Amps: 1,203
Three-Phase 277/480 VAC @0.8pf	400 kW	Amps: 601
Three-Phase 346/600 VAC @0.8pf	400 kW	Amps: 481

**MOTOR STARTING CAPABILITIES (SKVA)**

skVA vs. Voltage Dip			
277/480 VAC	30%	208/240 VAC	30%
K0400124Y21	1,174	K0500124Y21	730
K0500124Y21	1,020	K0600124Y2	1,120
K0600124Y21	1,560		

**FUEL CONSUMPTION RATES\***

Fuel Pump Lift - ft (m)	Percent Load	Diesel - gph (Lph)
12 (3.7)	Standby	9.8 (37.1)
	25%	16.7 (63.2)
	50%	23.1 (87.4)
	75%	27.8 (105.4)
	100%	
Total Fuel Pump Flow (Combustion + Return) - gph (Lph)		
159 (600)		

\* Fuel supply installation must accommodate fuel consumption rates at 100% load.

**COOLING**

		Standby
Air Flow (Fan Air Flow Across Radiator)	cfm (m <sup>3</sup> /min)	18,685 (529)
Coolant Flow	gpm (Lpm)	106 (402)
Coolant System Capacity	gal (L)	13 (49)
Heat Rejection to Coolant	BTU/hr (kW)	792,960 (232.3)
Maximum Operating Ambient Temperature	°F (°C)	122 (50)
Maximum Operating Ambient Temperature (Before Derate)	See Bulletin No. 0199280SSD	
Maximum Additional Radiator Backpressure	in H <sub>2</sub> O (kPa)	0.5 (0.12)

**COMBUSTION AIR REQUIREMENTS**

Flow at Rated Power cfm — (m <sup>3</sup> /min)	Standby/Demand Response
	1,180 (33.4)

**ENGINE**

		Standby
Rated Engine Speed	rpm	1,800
Horsepower at Rated kW**	hp	578
Piston Speed	ft/min (m/min)	1,854 (565)
BMEP	psi	334

\*\* See "Emissions Data Sheet" for maximum bHP for EPA and SCAQMD permitting purposes.

**EXHAUST**

		Standby
Exhaust Flow (Rated Output)	cfm (m <sup>3</sup> /min)	3,044 (86.2)
Maximum Allowable Back Pressure (Post Silencer)	in H <sub>2</sub> O (kPa)	1.5 (5.1)
Exhaust Temp (Rated Output - Post Turbo)	°F (°C)	1,256 (680)

Standby - See Bulletin 0187500SSB

Prime - See Bulletin 0187510SSB

Deration – Operational characteristics consider maximum ambient conditions. Derate factors may apply under atypical site conditions.

Please contact a Generac Power Systems Industrial Dealer for additional details. All performance ratings in accordance with ISO3046, BS5514, ISO8528, and DIN6271 standards.

**DIMENSIONS AND WEIGHTS\***

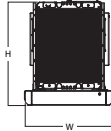
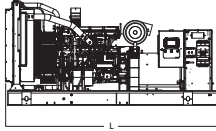

**OPEN SET**

Run Time - Hours	Usable Capacity - Gal (L)	L x W x H - in (mm)		Weight - lbs (kg)
No Tank	-	137.5 (3,493) x 57.6 (1,463) x 67.8 (1,721)		6,628 - 7,600 (3,006 - 3,447)
6	183 (693)	137.5 (3,493) x 57.6 (1,463) x 80.8 (2,051)		7,576 - 8,548 (3,436 - 3,877)
15	438 (1,659)	137.5 (3,493) x 57.6 (1,463) x 92.8 (2,356)		7,888 - 8,860 (3,577 - 4,018)
24	693 (2,624)	137.5 (3,493) x 57.6 (1,463) x 104.8 (2,661)		8,224 - 9,196 (3,730 - 4,171)
34	946 (3,581)	208.3 (5,292) x 57.6 (1,463) x 108.8 (2,761)		9,653 - 10,625 (4,378 - 4,819)
47	1,325 (5,015)	277.8 (7,055) x 57.6 (1,463) x 107.2 (2,721)		10,668 - 11,640 (4,839 - 5,280)

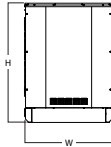
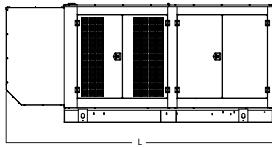

**LEVEL 0 SOUND ATTENUATED ENCLOSURE**

Run Time - Hours	Usable Capacity - Gal (L)	L x W x H - in (mm)		Weight - lbs (kg) Enclosure Only	
				Steel	Aluminum
No Tank	-	174.7 (4,437) x 57.5 (1,460) x 77.8 (1,976)		1,558 (707)	764 (347)
6	183 (693)	174.7 (4,437) x 57.5 (1,460) x 90.8 (2,306)			
15	438 (1,659)	174.7 (4,437) x 57.5 (1,460) x 102.8 (2,611)			
24	693 (2,624)	174.7 (4,437) x 57.5 (1,460) x 114.8 (2,916)			
34	946 (3,581)	208.3 (5,292) x 57.5 (1,460) x 118.8 (3,016)			
47	1,325 (5,015)	277.8 (7,055) x 57.5 (1,460) x 117.2 (2,976)			

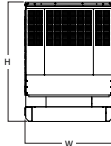
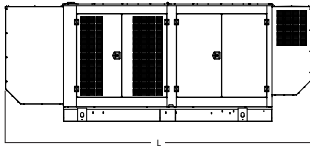

**LEVEL 1 SOUND ATTENUATED ENCLOSURE**

Run Time - Hours	Usable Capacity - Gal (L)	L x W x H - in (mm)		Weight - lbs (kg) Enclosure Only	
				Steel	Aluminum
No Tank	-	202.2 (5,085) x 57.5 (1,460) x 77.8 (1,976)		2,021 (917)	963 (437)
6	183 (693)	202.2 (5,085) x 57.5 (1,460) x 90.8 (2,306)			
15	438 (1,659)	202.2 (5,085) x 57.5 (1,460) x 102.8 (2,611)			
24	693 (2,624)	202.2 (5,085) x 57.5 (1,460) x 114.8 (2,916)			
34	946 (3,581)	208.3 (5,292) x 57.5 (1,460) x 118.8 (3,016)			
47	1,325 (5,015)	277.8 (7,055) x 57.5 (1,460) x 117.2 (2,976)			

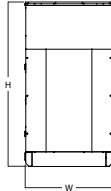
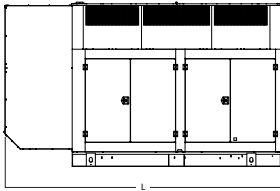

**LEVEL 2 SOUND ATTENUATED ENCLOSURE**

Run Time - Hours	Usable Capacity - Gal (L)	L x W x H - in (mm)		Weight - lbs (kg) Enclosure Only	
				Steel	Aluminum
No Tank	-	180.6 (4,588) x 53 (1,346) x 106.1 (2,696)		2,594 (1,177)	1,210 (549)
6	183 (693)	180.6 (4,588) x 53 (1,346) x 119.1 (3,026)			
15	438 (1,659)	180.6 (4,588) x 53 (1,346) x 131.1 (3,331)			
24	693 (2,624)	180.6 (4,588) x 53 (1,346) x 143.1 (3,636)			
34	946 (3,581)	208.3 (5,292) x 53 (1,346) x 147.1 (3,736)			
47	1,325 (5,015)	277.8 (7,055) x 53 (1,346) x 145.5 (3,696)			

\* All measurements are approximate and for estimation purposes only. Specification characteristics may change without notice. Please contact a Generac Power Systems Industrial Dealer for detailed installation drawings.