

**STANDBY POWER RATING**

25 kW, 31 kVA, 60 Hz

**PRIME POWER RATING\***

23 kW, 28 kVA, 60 Hz

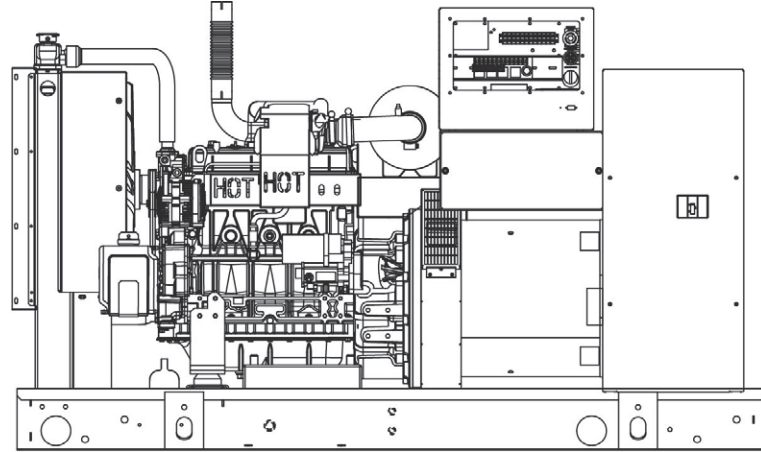

Image used for illustration purposes only



\*Built in the USA using domestic and foreign parts

\*EPA Certified Prime ratings are not available in the U.S. or its Territories.

\*\*Certain options or customization may not hold certification valid.

**CODES AND STANDARDS**

Generac products are designed to the following standards:

 UL2200, UL508, UL142, UL498

 NFPA70, 99, 110, 37

 NEC700, 701, 702, 708

 ISO9001, 8528, 3046, 7637, Pluses #2b, 4

 NEMA ICS10, MG1, 250, ICS6, AB1

 **ANSI**  
 American National Standards Institute  
 ANSI C62.41

**POWERING AHEAD**

For over 50 years, Generac has led the industry with innovative design and superior manufacturing.

Generac ensures superior quality by designing and manufacturing most of its generator components, including alternators, enclosures and base tanks, control systems and communications software.

Generac's gensets utilize a wide variety of options, configurations and arrangements, allowing us to meet the standby power needs of practically every application.

Generac searched globally to ensure the most reliable engines power our generators. We choose only engines that have already been proven in heavy-duty industrial application under adverse conditions.

Generac is committed to ensuring our customers' service support continues after their generator purchase.

## STANDARD FEATURES

### ENGINE SYSTEM

#### General

- Oil Drain Extension
- Air Cleaner
- Fan Guard
- Stainless Steel flexible exhaust connection
- Critical Exhaust Silencer (enclosed only)
- Factory Filled Oil
- Radiator Duct Adapter (open set only)

#### Fuel System

- Fuel lockoff solenoid
- Primary fuel filter

#### Cooling System

- Closed Coolant Recovery System
- UV/Ozone resistant hoses
- Factory-Installed Radiator
- Radiator Drain Extension
- 50/50 Ethylene glycol antifreeze
- 120 VAC Coolant Heater

#### Engine Electrical System

- Battery charging alternator
- Battery cables
- Battery tray
- Solenoid activated starter motor
- Rubber-booted engine electrical connections

### ALTERNATOR SYSTEM

- UL2200 GENprotect™
- 12 leads (3-phase, non 600 V)
- Class H insulation material
- Vented rotor
- 2/3 pitch
- Skewed stator
- Auxiliary voltage regulator power winding
- Amortisseur winding
- Brushless Excitation
- Sealed Bearings
- Automated manufacturing (winding, insertion, lacing, varnishing)
- Rotor dynamically spin balanced
- Full load capacity alternator
- Protective thermal switch

### GENERATOR SET

- Internal Genset Vibration Isolation
- Separation of circuits - high/low voltage
- Separation of circuits - multiple breakers
- Silencer Heat Shield
- Wrapped Exhaust Piping
- Silencer housed in discharge hood (enclosed only)
- Standard Factory Testing
- 2 Year Limited Warranty (Standby rated Units)
- 1 Year Limited Warranty (Prime rated Units)
- Silencer mounted in the discharge hood (enclosed only)

### ENCLOSURE (IF SELECTED)

- Rust-proof fasteners with nylon washers to protect finish
- High performance sound-absorbing material
- Gasketed doors
- Stamped air-intake louvers
- Air discharge hoods for radiator-upward pointing
- Stainless steel lift off door hinges
- Stainless steel lockable handles
- Rhino Coat™ - Textured polyester powder coat

### TANKS (IF SELECTED)

- UL 142
- Double wall
- Vents
- Sloped top
- Sloped bottom
- Factory pressure tested (2 psi)
- Rupture basin alarm
- Fuel level
- Check valve in supply and return lines
- Rhino Coat™ - Textured polyester powder coat
- Stainless hardware

### CONTROL SYSTEM



#### Control Panel

- Digital H Control Panel - Dual 4x20 Display
- Programmable Crank Limiter
- 7-Day Programmable Exerciser
- Special Applications Programmable PLC
- RS-232/485
- All-Phase Sensing DVR
- Full System Status
- Utility Monitoring
- Low Fuel Pressure Indication
- 2-Wire Start Compatible
- Power Output (kW)

- Power Factor
- kW Hours, Total & Last Run
- Real/Reactive/Apparent Power
- All Phase AC Voltage
- All Phase Currents
- Oil Pressure
- Coolant Temperature
- Coolant Level
- Engine Speed
- Battery Voltage
- Frequency
- Date/Time Fault History (Event Log)
- Isochronous Governor Control
- Waterproof/sealed Connectors
- Audible Alarms and Shutdowns
- Not in Auto (Flashing Light)
- Auto/Off/Manual Switch
- E-Stop (Red Mushroom-Type)
- NFPA110 Level I and II (Programmable)
- Customizable Alarms, Warnings, and Events
- Modbus protocol
- Predictive Maintenance algorithm
- Sealed Boards
- Password parameter adjustment protection

- Single point ground
- 15 channel data logging
- 0.2 msec high speed data logging
- Alarm information automatically comes up on the display

#### Alarms

- Oil Pressure (Pre-programmable Low Pressure Shutdown)
- Coolant Temperature (Pre-programmed High Temp Shutdown)
- Coolant Level (Pre-programmed Low Level Shutdown)
- Low Fuel Pressure Alarm
- Engine Speed (Pre-programmed Over speed Shutdown)
- Battery Voltage Warning
- Alarms & warnings time and date stamped
- Alarms & warnings for transient and steady state conditions
- Snap shots of key operation parameters during alarms & warnings
- Alarms and warnings spelled out (no alarm codes)

## CONFIGURABLE OPTIONS

### ENGINE SYSTEM

#### General

- Oil Heater
- Industrial Exhaust Silencer

#### Fuel System

- Flexible fuel lines
- Primary fuel filter

#### Engine Electrical System

- 10A UL battery charger
- 2.5A UL battery charger
- Battery Warmer

### ALTERNATOR SYSTEM

- Alternator Upsizing
- Anti-Condensation Heater
- Tropical coating
- Permanent Magnet Excitation

## ENGINEERED OPTIONS

### ENGINE SYSTEM

- Coolant heater ball valves
- Block Heaters
- Fluid containment pans

### ALTERNATOR SYSTEM

- 3rd Breaker Systems

### CONTROL SYSTEM

- Spare inputs (x4) / outputs (x4) - H Panel Only
- Battery Disconnect Switch

### CIRCUIT BREAKER OPTIONS

- Main Line Circuit Breaker
- 2nd Main Line Circuit Breaker
- Shunt Trip and Auxiliary Contact
- Electronic Trip Breaker

### GENERATOR SET

- Gen-Link Communications Software (English Only)
- 8 Position Load Center
- 2 Year Extended Warranty
- 5 Year Warranty
- 5 Year Extended Warranty

### ENCLOSURE

- Weather Protected
- Level 1 Sound Attenuation
- Level 2 Sound Attenuation
- Steel Enclosure
- Aluminum Enclosure
- 150 MPH Wind Kit
- 12 VDC Enclosure Lighting Kit
- 120 VAC Enclosure Lighting Kit
- AC/DC Enclosure Lighting Kit
- Door Alarm Switch

### GENERATOR SET

- Special Testing
- IBC Seismic Certification

### ENCLOSURE

- Motorized Dampers
- Door switched for intrusion alert
- Enclosure ambient heaters

### TANKS (Size on last page)

- Electrical Fuel Level
- Mechanical Fuel Level
- 54 Gal (204.4 L) Usable Capacity
- 132 Gal (499.7 L) Usable Capacity
- 211 Gal (798.7 L) Usable Capacity
- 300 Gal (1135.6 L) Usable Capacity
- 8" Fill Extension
- 13" Fill Extension
- 19" Fill Extension

### CONTROL SYSTEM

- 21-Light Remote Annunciator
- Remote Relay Panel (8 or 16)
- Oil Temperature Sender with Indication Alarm
- Remote E-Stop (Break Glass-Type, Surface Mount)
- Remote E-Stop (Red Mushroom-Type, Surface Mount)
- Remote E-Stop (Red Mushroom-Type, Flush Mount)
- Remote Communication - Modem
- Remote Communication - Ethernet
- 10A Run Relay
- Ground Fault Indication and Protection Functions

### TANKS

- Overfill Protection Valve
- UL2085 Tank
- ULC S-601 Tank
- Stainless Steel Tank
- Special Fuel Tanks (MIDEQ and FL DEP/DERM, etc.)
- Vent Extensions

## RATING DEFINITIONS

**Standby** - Applicable for a varying emergency load for the duration of a utility power outage with no overload capability.

**Prime** - Applicable for supplying power to a varying load in lieu of utility for an unlimited amount of running time. A 10% overload capacity is available for 1 out of every 12 hours. The Prime Power option is only available on International applications. Power ratings in accordance with ISO 8528-1, Second Edition

**APPLICATION AND ENGINEERING DATA**

**ENGINE SPECIFICATIONS**

General

Make	Generac
EPA Emissions Compliance	Stationary Emergency
EPA Emissions Reference	See Emissions Data Sheet
Cylinder #	4
Type	In-Line
Displacement - L (cu In)	2.4 (146.46)
Bore - mm (in)	90 (3.54)
Stroke - mm (in)	94 (3.70)
Compression Ratio	21.3:1
Intake Air Method	Turbocharged
Cylinder Head Type	Cast Iron
Piston Type	Aluminium

Engine Governing

Governor	Electronic Isochronous
Frequency Regulation (Steady State)	+/- 0.25%

Lubrication System

Oil Pump Type	Gear
Oil Filter Type	Full Flow
Crankcase Capacity - L (qts)	6.2 (6.52)

Cooling System

Cooling System Type	Closed Recovery
Water Pump	Pre-Lubed, Self Sealing
Fan Type	Pusher
Fan Speed (rpm)	2698
Fan Diameter mm (in)	560 (22)
Coolant Heater Wattage	1500
Coolant Heater Standard Voltage	120 VAC

Fuel System

Fuel Type	Ultra Low Sulfur Diesel Fuel
Fuel Specifications	ASTM
Fuel Filtering (microns)	5
Fuel Injection	Distribution Injection Pump
Fuel Pump Type	Engine Driven Gear
Injector Type	Mechanical
Fuel Supply Line mm (in)	7.94 (0.31)
Fuel Return Line mm (in)	7.94 (0.31)

Engine Electrical System

System Voltage	12 VDC
Battery Charging Alternator	Std
Battery Size	See Battery Index 0161970SBY
Battery Voltage	12 VDC
Ground Polarity	Negative

**ALTERNATOR SPECIFICATIONS**

Standard Model	390
Poles	4
Field Type	Revolving
Insulation Class - Rotor	H
Insulation Class - Stator	H
Total Harmonic Distortion	<5%
Telephone Interference Factor (TIF)	<50

Standard Excitation	Synchronous
Bearings	Single Sealed Cartridge
Coupling	Direct, Flexible Disc
Load Capacity - Standby	100%
Prototype Short Circuit Test	Yes
Voltage Regulator Type	Digital
Number of Sensed Phases	All
Regulation Accuracy (Steady State)	± 0.25%

**OPERATING DATA**

**POWER RATINGS**

		Standby
Single-Phase 120/240 VAC @1.0pf	25 kW	Amps: 104
Three-Phase 120/208 VAC @0.8pf	25 kW	Amps: 87
Three-Phase 120/240 VAC @0.8pf	25 kW	Amps: 75
Three-Phase 277/480 VAC @0.8pf	25 kW	Amps: 38
Three-Phase 346/600 VAC @0.8pf	25 kW	Amps: 30

**STARTING CAPABILITIES (sKVA)**

		sKVA vs. Voltage Dip											
		480 VAC						208/240 VAC					
Alternator	kW	10%	15%	20%	25%	30%	35%	10%	15%	20%	25%	30%	35%
Standard	25	16	25	33	41	49	57	12	19	25	31	37	43
Upsize 1	35	24	36	48	60	72	84	18	27	36	45	54	63
Upsize 2	40	27	41	54	68	81	95	20	31	41	51	61	71

**FUEL CONSUMPTION RATES\***

		Diesel - gal/hr (l/hr)	
Fuel Pump Lift - ft (m)		Percent Load	Standby
3 (1)		25%	0.8 (3.0)
		50%	1.33 (5.0)
Total Fuel Pump Flow (Combustion + Return)		75%	1.67 (6.3)
4.5 gal/hr		100%	2.5 (9.5)

\* Fuel supply installation must accommodate fuel consumption rates at 100% load.

**COOLING**

		Standby
Coolant Flow per Minute	gal/min (l/min)	10 (38)
Coolant System Capacity	gal (L)	2.8 (10.95)
Heat Rejection to Coolant	BTU/hr	103,080
Inlet Air	cfm (m3/hr)	4,500 (7647)
Max. Operating Radiator Air Temp	F° (C°)	122 (50)
Max. Ambient Temperature (before derate)	F° (C°)	110 (43.3)
Maximum Radiator Backpressure	in H <sub>2</sub> O	0.5

**COMBUSTION AIR REQUIREMENTS**

	Standby
Flow at Rated Power cfm (m3/min)	90 (2.55)

**ENGINE**

		Standby
Rated Engine Speed	rpm	1800
Horsepower at Rated kW**	hp	49
Piston Speed	ft/min (m/min)	1110 (338)
BMEP	psi	117

**EXHAUST**

		Standby
Exhaust Flow (Rated Output)	cfm (m <sup>3</sup> /min)	208 (354)
Max. Backpressure (Post Silencer)	inHg (Kpa)	1.5 (5.1)
Exhaust Temp (Rated Output)	°F (°C)	790 (421)
Exhaust Outlet Size (Open Set)	mm (in)	63.5 (2.5)

\*\* Refer to "Emissions Data Sheet" for maximum bHP for EPA and SCAQMD permitting purposes.

Deration – Operational characteristics consider maximum ambient conditions. Derate factors may apply under atypical site conditions. Please consult a Generac Power Systems Industrial Dealer for additional details. All performance ratings in accordance with ISO3046, BS5514, ISO8528 and DIN6271 standards.

**DIMENSIONS AND WEIGHTS\***

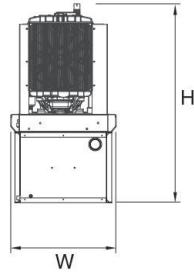
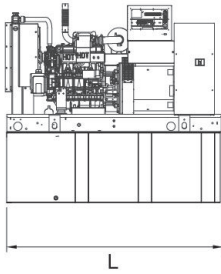

**OPEN SET**

RUN TIME HOURS	USABLE CAPACITY GAL (L)	L x W x H in (mm)	WT lbs (kg) - Tank & Open Set	
			Steel	Aluminum
NO TANK	-	76 (1930.4) x 37.4 (949.9) x 42.2 (1072.1)	2060 (934)	
21	54 (204.4)	76 (1930.4) x 37.4 (949.9) x 55.2 (1402.1)	2540 (1152)	
52	132 (499.7)	76 (1930.4) x 37.4 (949.9) x 67.2 (1706.9)	2770 (1257)	
84	211 (798.7)	76 (1930.4) x 37.4 (949.9) x 79.2 (2011.7)	2979 (1351)	
120	300 (1135.6)	92.9 (2360) x 37.4 (949.9) x 82.7 (2100.6)	3042 (1380)	

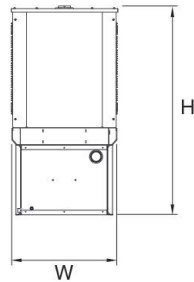
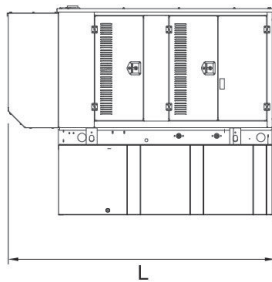

**STANDARD ENCLOSURE**

RUN TIME HOURS	USABLE CAPACITY GAL (L)	L x W x H in (mm)	WT lbs (kg) - Enclosure Only	
			Steel	Aluminum
NO TANK	-	94.8 (2408.9) x 38 (965.2) x 49.5 (1258.1)		
21	54 (204.4)	94.8 (2408.9) x 38 (965.2) x 62.5 (1587.5)		
52	132 (499.7)	94.8 (2408.9) x 38 (965.2) x 74.5 (1892.3)	302 (137)	191 (87)
84	211 (798.7)	94.8 (2408.9) x 38 (965.2) x 86.5 (2197.1)		
120	300 (1135.6)	94.8 (2408.9) x 38 (965.2) x 90 (2286)		

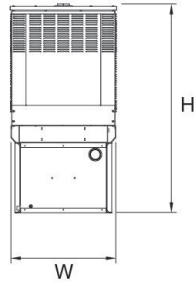
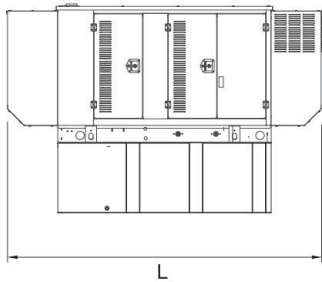

**LEVEL 1 ACOUSTIC ENCLOSURE**

RUN TIME HOURS	USABLE CAPACITY GAL (L)	L x W x H in (mm)	WT lbs (kg) - Enclosure Only	
			Steel	Aluminum
NO TANK	-	112.5 (2857.1) x 38 (965.2) x 49.5 (1258.1)		
21	54 (204.4)	112.5 (2857.1) x 38 (965.2) x 62.5 (1587.5)		
52	132 (499.7)	112.5 (2857.1) x 38 (965.2) x 74.5 (1892.3)	455 (206)	288 (131)
84	211 (798.7)	112.5 (2857.1) x 38 (965.2) x 86.5 (2197.1)		
120	300 (1135.6)	112.5 (2857.1) x 38 (965.2) x 90 (2286)		

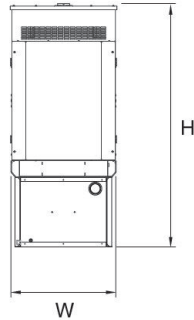
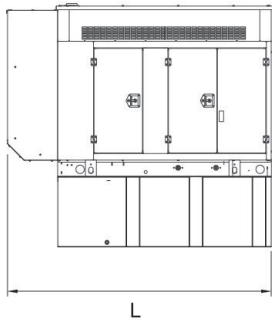

**LEVEL 2 ACOUSTIC ENCLOSURE**

RUN TIME HOURS	USABLE CAPACITY GAL (L)	L x W x H in (mm)	WT lbs (kg) - Enclosure Only	
			Steel	Aluminum
NO TANK	-	94.8 (2408.9) x 38 (965.2) x 62 (1573.9)		
21	54 (204.4)	94.8 (2408.9) x 38 (965.2) x 75 (1905)		
52	132 (499.7)	94.8 (2408.9) x 38 (965.2) x 87 (2209.8)	460 (209)	291 (132)
84	211 (798.7)	94.8 (2408.9) x 38 (965.2) x 99 (2514.6)		
120	300 (1135.6)	94.8 (2408.9) x 38 (965.2) x 102.5 (2603.5)		

\*All measurements are approximate and for estimation purposes only. Sound dBA can be found on the sound data sheet. Enclosure Only weight is added to Tank & Open Set weight to determine total weight.

YOUR FACTORY RECOGNIZED GENERAC INDUSTRIAL DEALER

Specification characteristics may change without notice. Dimensions and weights are for preliminary purposes only. Please consult a Generac Power Systems Industrial Dealer for detailed installation drawings.